

Data Sheet

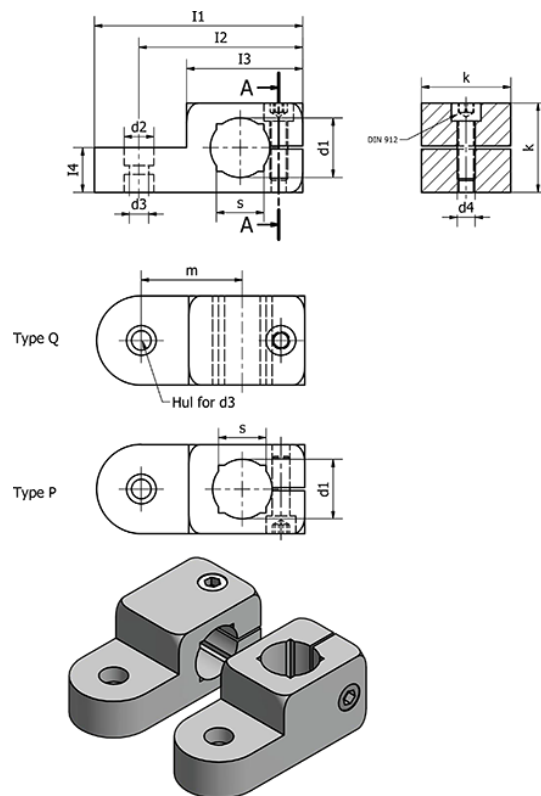

Article number: 20482B1020QMT
 Description: E+G Swivel clamp
 GN 482-B10-20-Q-MT

Measures



	= -	l1	= 50
	= -	l3	= 40
Clamping kit for d3 = GN 511.1-M5-20-S/K		l4	= 10
Clamping kit for d4 = GN 511-M5-20		k	= 20
d1	= 10	m	= 23
d2	= 8.5	s	= 8
d3	= 5.5	Weight (g)	= 35
d4	= M5		